

SUPRA

Stainless Steel
Single Wall
Chimney System
for Condensing
Appliances

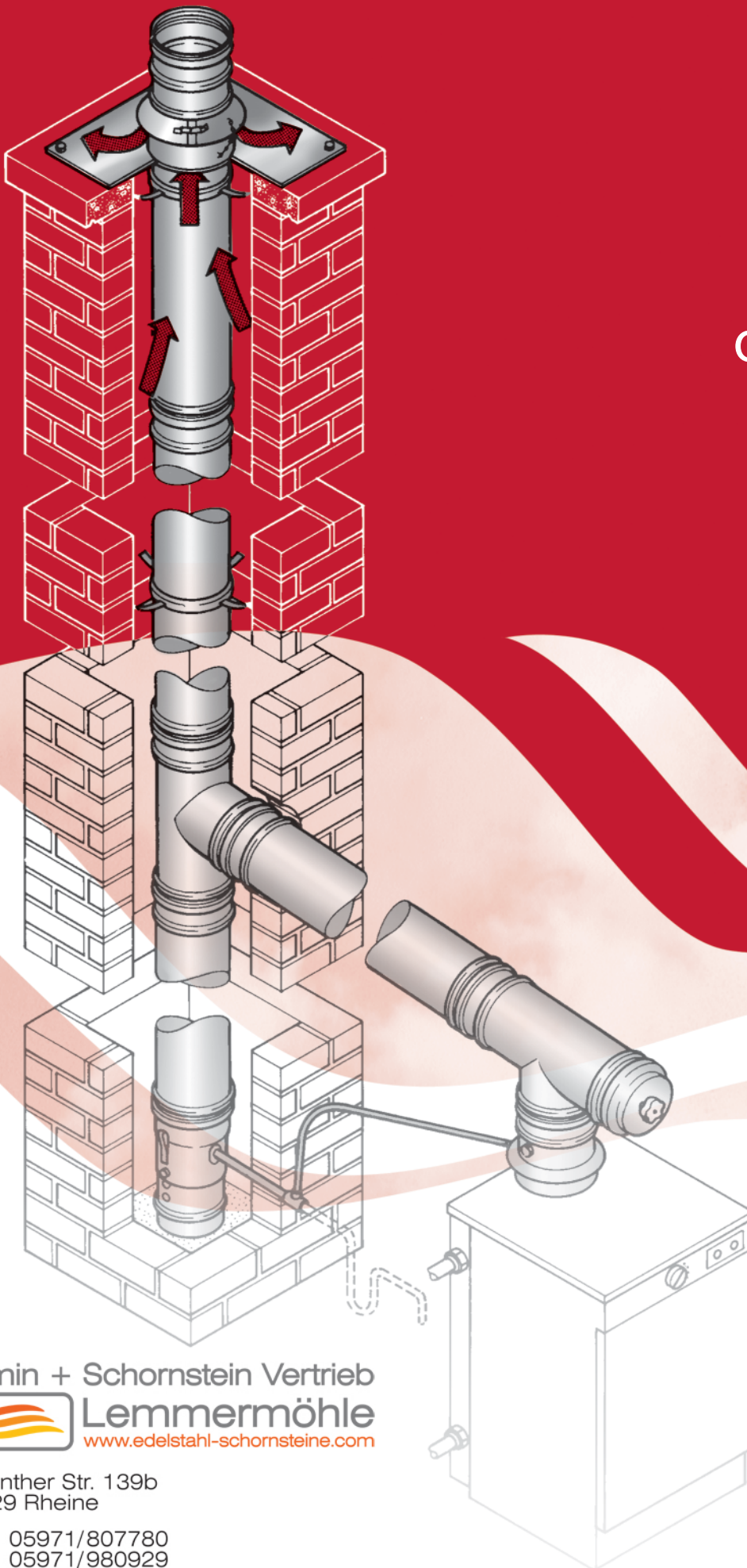

Kamin + Schornstein Vertrieb



Lemmermöhle
www.edelstahl-schornsteine.com

Dörenther Str. 139b
48429 Rheine

Tel. 05971/807780
Fax. 05971/980929
free. 0800/52646984
mail. mail@edelstahl-schornsteine.com

flues & chimneys

Confidence In Quality

PRODUCT INFORMATION

The Supra chimney system range is specifically designed to meet the demands of the latest high efficiency condensing heating appliances. The Supra product also comes complete with factory fitted and bonded elastomer seals, offering peace of mind and reduced installation time for the installer.

INTRODUCTION

Supra is a single-wall pre-fabricated stainless steel flue system, primarily designed for gas and kerosene (28Sec) oil fired appliances, which produce condensates and positive pressure conditions as a function of their operation, such as high efficiency condensing appliances.

Supra is also available with a 1mm thick liner and can be used for the same applications as the standard product when fitted with seals. Alternatively it can be used for lining existing brick stacks where the flue gas temperatures will not exceed 450°C (550°C Intermittent).

DESCRIPTION

Supra is manufactured in 14 diameters ranging from 80mm to 600mm and consists of a range of lengths and fittings which simply push-fit together, and which are secured with a Locking Band. The entire system is manufactured from corrosion resistant grade 316L (1.4404:X2CrNiMo 17-12-2) stainless steel and is manufactured using a fully welded construction and precision formed close tolerance joints.

The standard supra product is specifically designed for condensing applications and covers a diameter range from 80mm to 350mm inclusive and is supplied complete with factory fitted elastomer seals.

The Supra 1mm product covers a diameter range from 180mm to 600mm inclusive. Due to the increased range of application with the 1mm Supra alternative, elastomer seals are **NOT** factory fitted and must be ordered separately with each component if required.

Please note that whilst some of the standard and 1.0mm Supra products have the same diameter, the product joints are **NOT** compatible - DO NOT MIX them.

The Supra product is available with a wide range of support components that cater for both lateral and vertical structural loading of the product. SFL do not recommend any other system of support being used with the Supra product, unless approved by SFL prior to installation.

Application

The standard Supra product is primarily designed for internal applications and for use on high efficiency gas / kerosene fired condensing appliances and for applications where the chimney could be under positive pressure conditions not exceeding 200Pa at a maximum flue gas temperature of 200°C.

The Supra 1.0mm product can be used for solid fuel applications (including wood) where the flue gas temperature will not exceed 450°C (550°C intermittent) and only where used as a connecting flue pipe from the appliance to the chimney and where connection is made in the same room. Supra 1mm can also be used as a rigid chimney liner within a masonry chimney. Under no circumstances should elastomer seals be fitted where the chimney system serves solid fuel applications.

Where Supra 1.0mm is being used for commercial condensing applications above 350mm internal diameter, either as a chimney or liner, elastomer seals will need to be purchased and fitted separately for each component / joint.

When fluing condensing appliances and where the chimney is external to the building, there is a risk that the condensates could freeze. In such cases, SFL would recommend that a twin wall insulated product such as Nova SM is used to prevent this. Regulations now require all domestic external flue runs over 3m to be made from twin wall insulated product manufactured with a stainless steel liner.

Care should be taken where there is a risk of accidental human contact with Supra. Although most condensing appliance produce flue gas temperatures in the region of 30-50°C, it is possible that in non-condensing mode the flue gases can achieve much higher temperatures. For instances where the flue gas temperature of the appliance can rise above 70°C and there is the possibility of accidental human contact, a twin wall insulated product such as the Nova SM should be used.



Approvals

The Supra product is CE certified to BS EN 1856-1 & 2 certificate No. 0086-CPD-496040 to the performance designations as detailed in Table A below.

Table A

Supra product designations to BS EN 1856-1/2							
Supra	BS EN 1856-1	T200	P1	W	V2	L50050	O(300)
Supra 1.0	BS EN 1856-1	T450	N1	D	V2	L50100	G(450)
Supra 1.0 (S)	BS EN 1856-1	T200	P1	W	V2	L50100	O(300)
Supra	BS EN 1856-2	T200	P1	W	V2	L50050	O
Supra 1.0	BS EN 1856-2	T450	N1	D	V2	L50100	G
Supra 1.0 (S)	BS EN 1856-2	T200	P1	W	V2	L50100	O
Standard number	↑						
Temperature class	↑						
Pressure class	↑						
Condense resistance D=dry W=wet	↑						
Corrosion class	↑						
Material specification Liner grade 316L Liner thickness: 0.5mm / 1.0mm	↑						
Sootfire resistance G=yes O=no	↑						
	Product to EN1856-2 relate to chimney liners within a non-combustible shaft. (S) Denotes fitted Seals.						

Quality

All components are manufactured under a quality assurance scheme, certificate No. FM 01079, administered by British Standards in accordance with BS EN 9001: 2000. In addition SFL operate a CE approved factory production control system as required under the Construction Products Directive 93/68/EEC.

Installation / Regulations

Connection to an appliance which is not connected to the fuel supply, may be carried out by a competent person. However, connection to an appliance that is connected to the fuel supply MUST be carried out by an approved and registered heating engineer, e.g. Gas Safe, HETAS (Solid Fuel) or OFTEC (Oil).

The Installation of the Supra product must be in accordance with local building regulations and associated National Standards and Code of Practice. Relevant standards are as follows:-

Document J - DOE Building Regulations
Section F - Building Standards (Scotland)
Section L - Building Regulations (Northern Ireland)
Solid Fuel & Oil Fired Appliances: BS EN15287-1:2007
Domestic Gas Installations: BS5440: Part 1: 2008

Where Supra 1.0mm is used to connect a domestic solid fuel appliance, e.g. stove, connection from the appliance to either a twin wall chimney or brick stack is made in the same room as the appliance. When connecting to a twin wall chimney, the connection between the joint must be at least 150mm below the ceiling.

The connecting flue must also be positioned so that it is located at a distance of 3 x diameter to any adjacent combustible material.

Where Supra is used to reline an existing stack, it is imperative that the product is not supported by suspending from the top of the stack. In all instances the liner must be lowered down the stack using a Support Length at the bottom. Location Bands must then be used at intervals not exceeding 3.0 metres. The Location Bands are to be secured underneath a joint and are designed to centrally locate and brace the system when lowered into an existing chimney or shaft. When required, the Location Bands can be manufactured to bespoke dimensions provided by the customer to suit the required chimney / shaft dimensions.

For condensing (WET) applications it is important that horizontal sloping runs are angled not less than 5° to the horizontal. Components such as the 85° Elbow and 95° Tee are available to facilitate the 5° incline from the horizontal. Drainage components MUST be used strategically within the system to facilitate the removal of condensation, see Fig 3. Where 1mm Supra is used on condensing applications, Elastomer Seals must be fitted and preferably bonded to the product. Prior to making the joint, ensure that both mating ends are clean and free of dirt and apply a generous amount of SFL Seal Lubricant around the face of the seal to aid installation.

Commercial Applications

The Supra Product is suitable for commercial applications up to and including 600ID. Due to the complexity of most installations, SFL can manufacture to order bespoke components including special angled elbows, tees and multi-inlet manifolds. Please forward your requirements complete with detailed dimensioned drawing to SFL Technical Department who will assess your requirements.

SFL also employ state of the art CAD software to model the thermodynamic and flow characteristics of the proposed system, allowing the most economic system design to be achieved. All designs are calculated in accordance with EN 13384 parts 1 & 2. SFL can also offer advice on the Clean Air Act requirements and calculate chimney heights to the requirement of the Clean Air Act Memorandum. For further information please contact SFL Technical Department.

Elastomer Seal (P1 / W Applications)

The Elastomer Seal is located in the recess of the female end of the Supra chimney system as detailed in Fig 1. The standard Supra product comes complete with the Elastomer Seal factory fitted and bonded. On the 1mm Supra product, Joint Seals must be ordered separately. Where Supra is being used for condensing (WET) / positive pressure (P1) applications up to 200Pa at a maximum flue gas temperature of 200°C, Elastomer Seals MUST be fitted at each joint within the system.

Note: Joint Seals are only suitable for gas and 28Sec (Kerosene) applications within the above limits.

SUPRA JOINTING DETAILS

Fig 1

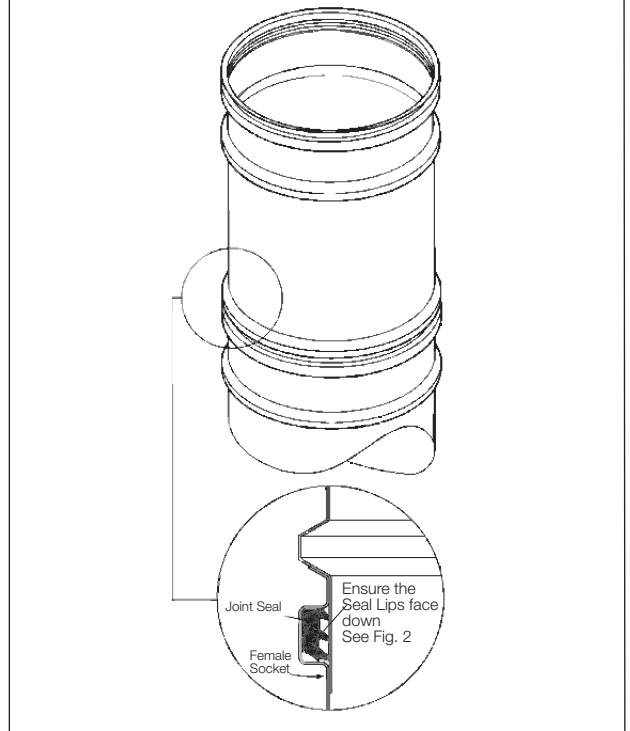

Where Elastomer Seals are being used, the chimney system must be installed with a minimum 5° incline to the horizontal to ensure adequate back drainage of condensation. Failure to maintain an adequate incline and lack of drainage component in the system may lead to premature failure of the product / seals.

Fig 2

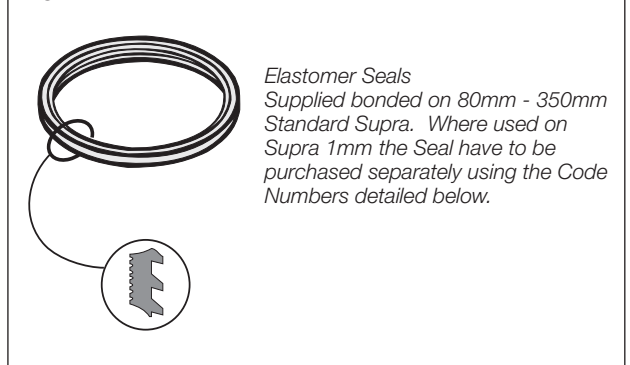

Seal Size	Code Number
80mm	40064008
100mm	40063010
113mm	40063011
130mm	40063013
150mm	40063015
180mm	40063018
200mm	40063020
250mm	40063025
300mm	40063030
350mm	40063035
400mm	40063040
500mm	40063050
600mm	40063060

INDIVIDUAL COMPONENTS

LENGTHS

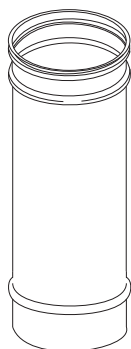

Available in 'nominal' installed lengths as detailed in the table below

Size	Installed Length (Std Supra)		
	Part Number		
	40101XX	40102XX	40103XX
80mm-150mm	988mm	458mm	193mm
180mm-350mm	969mm	459mm	204mm

Size	Installed Length (Supra 1.0)		
	Part Number		
	40201XX	40202XX	40203XX
180mm-600mm	975mm	459mm	204mm

Size	Lengths (Std. Supra)		
	988mm/ 969mm	458mm/ 459mm	193mm/ 204mm

Size	Code Number		
	80mm	4010108	4010208
100mm	4010110	4010210	4010310
113mm	4010111	4010211	4010311
130mm	4010113	4010213	4010313
150mm	4010115	4010215	4010315
180mm	4010118	4010218	4010318
200mm	4010120	4010220	4010320
250mm	4010125	4010225	4010325
300mm	4010130	4010230	4010330
350mm	4010135	4010235	4010335

Size	Lengths (Supra 1.0mm)		
	988mm/ 969mm	458mm/ 459mm	193mm/ 204mm

Size	Code Number		
	180mm	4020118	4020218
200mm	4020120	4020220	4020320
250mm	4020125	4020225	4020325
300mm	4020130	4020230	4020330
350mm	4020135	4020235	4020335
400mm	4020140	4020240	4020340
500mm	4020150	4020250	4020350
600mm	4020160	4020260	4020360

Locking Bands

This component must be used on every joint between components. Needs to be ordered separately

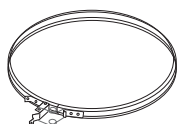

Size	Code Number
80mm	4017008
100mm	4017010
113mm	4017011
130mm	4017013
150mm	4017015
180mm	4027018
200mm	4027020
250mm	4027025
300mm	4027030
350mm	4027035
400mm	4027040
500mm	4027050
600mm	4027060

75mm minimum to 230mm maximum installed length

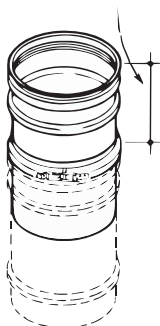

Adjustable Length

Designed to be used to make up a required length between two components. It should be used with a standard length which MUST be ordered separately. It can also be inserted into the female end of other components, but however applied, must engage a depth equivalent to at least half the diameter of the Supra being used. The Adjustable Length for Supra 0.5mm is also supplied with a special Locking Band and Seal which must only be used for condensing applications. Please note that the 1.0mm Supra product is NOT supplied with the special Locking Band and Seal and these MUST be ordered separately if required, see below. The Adjustable Length does not load bear. Always support the sections of Supra immediately above with a Wall Support or Support Plate. See Installation Instructions on page 11 for further details.

Thick Size	Specification and Code Numbers	
	0.5mm Supra	1.0mm Supra
80mm	4014408	-
100mm	4014410	-
113mm	4014411	-
130mm	4014413	-
150mm	4014415	-
180mm	4014418	4024418
200mm	4014420	4024420
250mm	4014425	4024425
300mm	4014430	4024430
350mm	4014435	4024435
400mm	-	4024440
500mm	-	4024450
600mm	-	4024460

Adjustable Locking Band and Seal (1.0mm Supra)

Where 1mm Supra product is used for WET / CONDENSING applications, this item MUST be ordered for each Adjustable Length.

Size	Code Number
180mm	4007218
200mm	4007220
250mm	4007225
300mm	4007230
350mm	4007235
400mm	4007240
500mm	4007250
600mm	4007260

Inspection Length

Designed to be installed within the system to allow access for inspection and cleaning. The door closes on an elastomer seal to provide a water and pressure resistant joint and must only be used where the flue gas temperature will NOT exceed 200°C. For high temperature applications both the inner and outer door seal must be removed prior to installation.

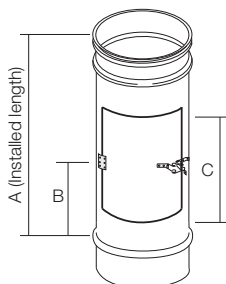

Size	Code No.		A	B	C
	0.5 mm Supra	1.0 mm Supra			
80mm	4011008	-	195	70	100
100mm	4011010	-	195	70	110
113mm	4011011	-	283	113	135
130mm	4011013	-	283	113	160
150mm	4011015	-	283	113	170
180mm	4011018	4021018	289	127	170
200mm	4011020	4021020	289	127	170
250mm	4011025	4021025	289	127	170
300mm	4011030	4021030	289	127	170
350mm	4011035	4021035	289	127	170
400mm	-	4021040	289	127	170
500mm	-	4021050	289	127	170
600mm	-	4021060	289	127	170

TEES AND ELBOWS

90° Tee

Used to provide a 90° connection in a system run or can be used as an access / inspection point when used with a Locking Plug

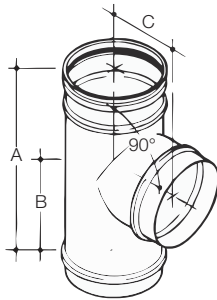

Size	Code No.	Code No.	A	B	C
	0.5 mm Supra	1.0 mm Supra			
80mm	4010508	-	283	110	90
100mm	4010510	-	283	110	90
113mm	4010511	-	283	112	95
130mm	4010513	-	283	112	100
150mm	4010515	-	283	112	125
180mm	4010518	4020518	289	126	131
200mm	4010520	4020520	459	211	131
250mm	4010525	4020525	459	211	217
300mm	4010530	4020530	459	211	217
350mm	4011035	4020535	459	211	217
400mm	-	4020540	969	466	303
500mm	-	4020550	969	466	303
600mm	-	4020560	969	466	477

135° Tee and 45° Elbow configuration

Used to provide a 90° connection in a system run or can be used as an access / inspection point when used with a Locking Plug

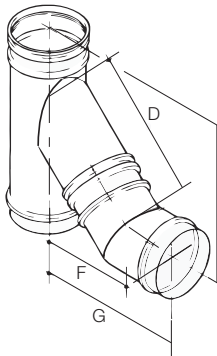

Size	D	E	F	G
80mm	-	-	-	-
100mm	-	-	-	-
113mm	283	310	200	242
130mm	308	319	218	264
150mm	336	352	238	288
180mm	376	417	266	343
200mm	404	427	286	367
250mm	476	453	337	429
300mm	546	900	386	488
350mm	616	750	436	548
400mm	697	783	493	632
500mm	839	832	593	753
600mm	979	881	692	872

135° Equal Tee

Used to provide a 45° connection in a system run or as the entry point to a chimney. Can be used as an access / inspection point when used with a Locking Plug or as a drain when fitted with a Condensate Collector.

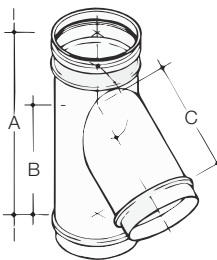

Size	Code No.	Code No.	A	B	C
	0.5 mm Supra	1.0 mm Supra			
80mm	4012280	-	-	-	-
100mm	4012210	-	-	-	-
113mm	4012211	-	283	173	177
130mm	4012213	-	283	182	198
150mm	4012215	-	327	213	222
180mm	4012218	4022218	459	308	256
200mm	4012220	4022220	459	318	280
250mm	4012225	4022225	459	343	341
300mm	4012230	4022230	969	455	401
350mm	4012235	4022235	969	655	461
400mm	-	4022240	969	679	521
500mm	-	4022250	969	730	642
600mm	-	4022260	969	780	762

95° Equal Tee

The tee is provided with a 5° connection on the branch to allow for condensate drainage. Can be used at the base of a vertical stack or to facilitate a 5° incline

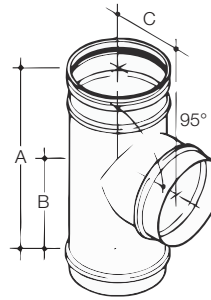

Size	Code No.	Code No.	A	B	C
	0.5 mm Supra	1.0 mm Supra			
80mm	4011908	-	283	107	90
100mm	4011910	-	283	108	90
113mm	4011911	-	283	110	90
130mm	4011913	-	283	109	100
150mm	4011915	-	327	108	125
180mm	4011918	4021918	289	126	131
200mm	4011920	4021920	459	211	131
250mm	4011925	4021925	459	211	217
300mm	4011930	4021930	459	211	217
350mm	4011935	4021935	459	211	217
400mm	-	4021940	969	466	303
500mm	-	4021950	969	466	303
600mm	-	4021960	969	466	477

Locking Plug

Used to close off the branch or base of a tee or the end of a header/manifold. Held in position with a Locking band.



Size	Code Number	A
80mm	4014908	82
100mm	4014910	82
113mm	4014911	82
130mm	4014913	82
150mm	4014915	82
180mm	4024918	70
200mm	4024920	70
250mm	4024925	70
300mm	4024930	70
350mm	4024935	70
400mm	4024940	70
500mm	4024950	70
600mm	4024960	70

Condensate Collector

Used at the bottom of a vertical run, usually under a Tee, to facilitate drainage of condensates from the system. The component includes a stainless steel BSP connection to allow drainage pipework to be connected by others.

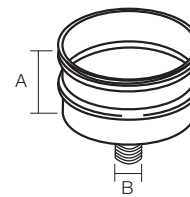

Size	Code Number	A	B
80mm	4014308	82	1"
100mm	4014310	82	1"
113mm	4014311	82	1"
130mm	4014313	82	1"
150mm	4014315	82	1"
180mm	4024318	70	1"
200mm	4024320	70	1"
250mm	4024325	70	1"
300mm	4024330	70	1"
350mm	4024335	70	1"
400mm	4024340	70	2"
500mm	4024350	70	2"
600mm	4024360	70	2"

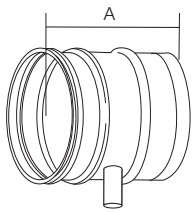

100-350: 1" BSP
400-600: 2" BSP

Horizontal Duct Drain

Used as a drainage point on the end of an inclined manifold or inclined run. Incorporates an internal condensate dam and BSP stainless steel connection for condensate drainage. Also supplied with fixed end cap. **Note: The Cap cannot be removed.**

With Cap

Size	0.5mm Supra		1mm Supra	
	Code No.	A	Code No.	A
100mm	4011810	182	-	-
113mm	4011811	182	-	-
130mm	4011813	182	-	-
150mm	4011815	182	-	-
180mm	4011818	182	4021818	200
200mm	4011820	182	4021820	200
250mm	4011825	182	4021825	200
300mm	4011830	193	4021830	200
350mm	4011835	193	4021835	200
400mm	-	-	4021840	200
500mm	-	-	4021850	200
600mm	-	-	4021860	200

Without Cap

Size	0.5mm Supra		1mm Supra	
	Code No.	A	Code No.	A
100mm	4010810	200	-	-
113mm	4010811	200	-	-
130mm	4010813	200	-	-
150mm	4010815	200	-	-
180mm	4010818	200	4020818	200
200mm	4010820	200	4020820	200
250mm	4010825	200	4020825	200
300mm	4010830	200	4020830	200
350mm	4010835	200	4020835	200
400mm	-	-	4020840	200
500mm	-	-	4020850	200
600mm	-	-	4020860	200

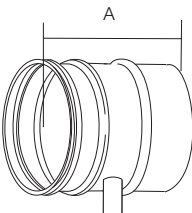

100-350: 1" BSP
400-600: 2" BSP

15° Elbow

Used to provide a 15° change of direction from the vertical.

Size	0.5mm Supra		1mm Supra			
	Code No.	A	Code No.	A		
80mm	4012508	26	141	-		
100mm	4012510	27	148	-		
113mm	4012511	23	113	-		
130mm	4012513	24	117	-		
150mm	4012515	24	119	-		
180mm	4012518	25	144	4022518	23	130
200mm	4012520	25	146	4022520	23	132
250mm	4012525	26	152	4022525	24	138
300mm	4012530	27	159	4022530	25	146
350mm	4012535	27	165	4022535	26	152
400mm	-	-	-	4022540	31	197
500mm	-	-	-	4022550	33	211
600mm	-	-	-	4022560	34	224

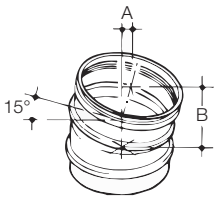

30° Elbow

Used to provide a 30° change of direction from the vertical.

Size	0.5mm Supra		1mm Supra			
	Code No.	A	Code No.	A		
80mm	4012408	58	157	-		
100mm	4012410	61	168	-		
113mm	4012411	49	119	-		
130mm	4012413	50	123	-		
150mm	4012415	52	128	-		
180mm	4012418	54	157	4022418	50	144
200mm	4012420	55	162	4022420	52	149
250mm	4012425	58	173	4022425	55	160
300mm	4012430	62	187	4022430	58	173
350mm	4012435	65	200	4022435	62	187
400mm	-	-	-	4022440	74	237
500mm	-	-	-	4022450	80	262
600mm	-	-	-	4022460	87	286

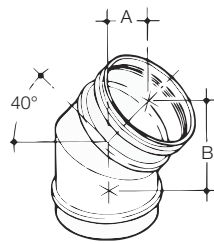
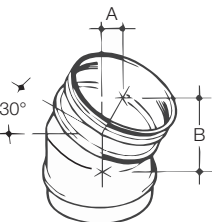

40° Elbow

Used to provide a 40° change of direction from the vertical.

Size	0.5mm Supra		1mm Supra			
	Code No.	A	Code No.	A		
80mm	4019808	84	172	-		
100mm	4019810	91	191	-		
113mm	4019811	67	120	-		
130mm	4019813	69	125	-		
150mm	4019815	71	130	-		
180mm	4019818	75	162	4029818	70	149
200mm	4019820	76	167	4029820	72	155
250mm	4019825	83	185	4029825	78	172
300mm	4019830	89	201	4029830	84	188
350mm	4019835	94	217	4029835	90	204
400mm	-	-	-	4029840	113	274
500mm	-	-	-	4029850	127	311
600mm	-	-	-	4029860	139	346

45° Elbow

Used to provide a 45° change of direction from the vertical.

Size	0.5mm Supra		1mm Supra			
	Code No.	A	Code No.	A		
80mm	4014308	92	164	-		
100mm	4014310	100	183	-		
113mm	4014311	75	117	-		
130mm	4014313	78	124	-		
150mm	4014315	81	131	-		
180mm	4014318	85	162	4022318	80	150
200mm	4014320	88	169	4022320	83	157
250mm	4014325	95	187	4022325	91	176
300mm	4014330	103	205	4022330	98	193
350mm	4014335	110	222	4022335	105	210
400mm	-	-	-	4022340	124	263
500mm	-	-	-	4022350	139	299
600mm	-	-	-	4022360	153	333

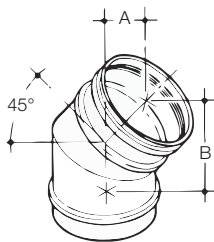

85° Elbow

Used to provide a 85° change of direction from the vertical. Also for use on condensing systems to allow a 5° incline to aid drainage of condensate back through the system.

Size	0.5mm Supra		1mm Supra			
	Code No.	A	Code No.	A		
80mm	4012708	145	100	-		
100mm	4012710	153	109	-		
113mm	4012711	156	113	-		
130mm	4012713	163	114	-		
150mm	4012715	172	124	-		
180mm	4012718	186	160	4022718	186	160
200mm	4012720	196	170	4022720	196	170
250mm	4012725	218	195	4022725	212	195
300mm	4012730	241	220	4022730	235	219
350mm	4012735	264	245	4022735	258	244
400mm	-	-	-	4022740	343	338
500mm	-	-	-	4022750	388	386
600mm	-	-	-	4022760	434	437

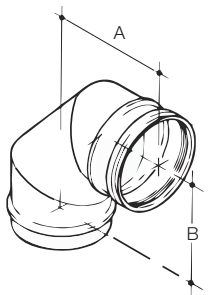

90° Elbow

Used to provide a 90° change of direction.

Size	0.5mm Supra		1mm Supra			
	Code No.	A	Code No.	A		
80mm	4012808	150	90	-		
100mm	4012810	160	100	-		
113mm	4012811	162	105	-		
130mm	4012813	171	107	4022713	171	128
150mm	4012815	180	116	4022715	180	137
180mm	4012818	196	153	4022718	196	153
200mm	4012820	205	162	4022720	205	162
250mm	4012825	231	188	4022725	225	188
300mm	4012830	255	212	4022730	249	212
350mm	4012835	280	237	4022735	274	237
400mm	-	-	-	4022740	357	320
500mm	-	-	-	4022750	405	368
600mm	-	-	-	4022760	452	415

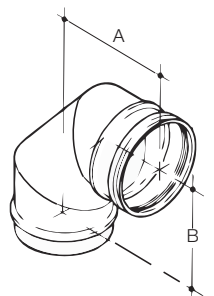

ADAPTORS

Appliance Adaptor

Used to connect the Supra product to the appliance. The interface between the Adaptor and the appliance outlet should be sealed with silicon sealant when used on condensing appliances or fire cement when used on solid fuel.

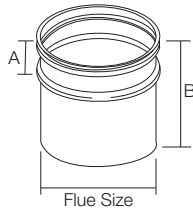

Size	0.5mm Supra		1mm Supra			
	Code No.	A	B	Code No.	A	B
80mm	4019308	63	205	-	-	-
100mm	4019310	63	205	-	-	-
113mm	4019311	63	205	-	-	-
130mm	4019313	63	205	-	-	-
150mm	4019315	63	205	-	-	-
180mm	4019318	42	197	4028318	42	197
200mm	4019320	42	197	4028320	42	197
250mm	4019325	42	197	4028325	42	197
300mm	4019330	42	197	4028330	42	197
350mm	4019335	42	197	4028335	42	197
400mm	-	-	-	4028340	42	197
500mm	-	-	-	4028350	42	197
600mm	-	-	-	4028360	42	197

Appliance Adaptor with Condense Trap

Used to connect the Supra product to the appliance and drain condensate from the system where used on high efficiency and condensing appliances. The interface between the Adaptor and the appliance outlet should be sealed with silicon sealant. The design helps divert condensates through an 18mm OD stainless steel tube to which drain hose can be connected, prior to entering the appliance.

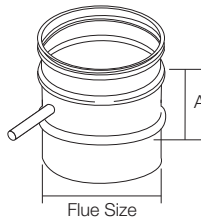

Positioned as an in-line condensate appliance adaptor

Size	0.5mm Supra		1mm Supra	
	Code No.	A	Code No.	A
80mm	4011408	130	-	-
100mm	4011410	130	-	-
113mm	4011411	130	-	-
130mm	4011413	130	-	-
150mm	4011415	130	-	-
180mm	4011418	130	4021418	130
200mm	4011420	130	4021420	130
250mm	4011425	130	4021425	130
300mm	4011430	130	4021430	130
350mm	4011435	130	4021435	130
400mm	-	-	4021440	130
500mm	-	-	4021450	130
600mm	-	-	4021460	130

Supra to Nova adaptor

Designed to facilitate connection from the Supra to Nova chimney system.

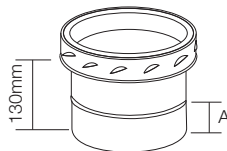

Size	A	Code Number
100mm	63	4579604N
130mm	63	4579605N
150mm	63	4579606N
180mm	42	4579607N
200mm	42	4579608N
250mm	42	4579610N
300mm	42	4579612N
350mm	42	4579614N

Nova to Supra adaptor

Designed to facilitate connection from the Nova to Supra chimney system.

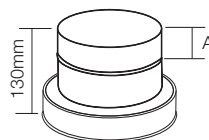

Size	A	Code Number
100mm	63	4579704N
130mm	63	4579705N
150mm	63	4579706N
180mm	42	4579707N
200mm	42	4579708N
250mm	42	4579710N
300mm	42	4579712N
350mm	42	4579714N

Adaptor to Flex

Used to connect the Supra product to a flexible flue/chimney liner.

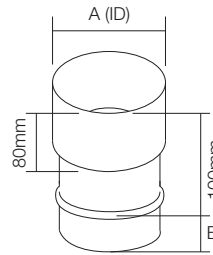

Size	Dimensions		Code Number
	A	B	
80mm	88	63	4015908
100mm	108	63	4015910
130mm	138	63	4015913
150mm	158	63	4015915
180mm	188	63	4025918
200mm	208	63	4025920

SUPPORT COMPONENTS

Support Length

The Support Length can serve two applications, firstly allowing a Supra liner to be lowered down a chimney and secondly as a Support Length when used with the Support Plate (less the collar).

In all cases, ALL the lugs on the Support Length MUST be used when lowering the product. The maximum length of product that can be supported by the component is 30 metres.

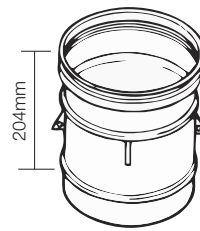

Specification and Code Numbers	Code Numbers	
	0.5mm Supra	1.0mm Supra
Thick		
Size		
80mm	4010408	-
100mm	4010410	-
113mm	4010411	-
130mm	4010413	-
150mm	4010415	-
180mm	4010418	4020418
200mm	4010420	4020420
250mm	4010425	4020425
300mm	4010430	4020430
350mm	4010435	4020435
400mm	-	4020440
500mm	-	4020450
600mm	-	4020460

Bracing Bracket

Used to provide lateral stability back to support structure. This component must only be used with rigid stays and can be fitted anywhere on the pipe other than between the swages. Structural calculations must be made for each application. Rigid stays must be connected to the three fixing points of this three part component. The hole diameters for the M6 nuts and bolts are 7mm. Constructed from stainless steel.

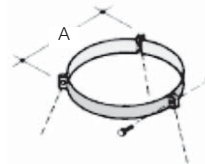

Size	A	Code Number
60mm	62	4069206
80mm	82	4069208
100mm	102	4069210
113mm	115	4069211
130mm	132	4069213
150mm	152	4069215
180mm	182	4069218
200mm	202	4069220
250mm	252	4069225
300mm	302	4069230
350mm	352	4069235
400mm	402	4069240
500mm	502	4069250
600mm	602	4069260

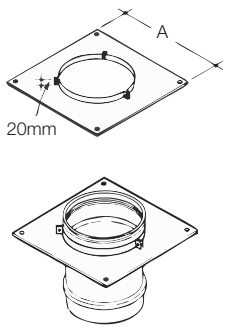

Support Plate

Consists of a stainless steel plate with a three part support collar. The collar rests on the plate and is located under the bead/swage at a joint between components. The three fixing points of the collar rest on the plate, the hole in which being large enough to permit the passage of the swages of the Supra construction.

The plate must be adequately supported and secured to an adjacent structure. This component can also be used in conjunction with a Support Length, but the collar would be discarded for this application.

This component or a Wall Support MUST ALWAYS be used above an Adjustable Length where applied in a vertical application, or where the Adjustable Length would be otherwise liable to load. The maximum length which can be supported by this component is 30 metres.

Size	A	Code Number
80mm	147	4051108
100mm	260	4051110
113mm	260	4051111
130mm	275	4051113
150mm	300	4051115
180mm	325	4051118
200mm	350	4051120
250mm	400	4051125
300mm	450	4051130
350mm	500	4051135
400mm	550	4051140
500mm	650	4051150
600mm	750	4051160

Wall Support Bracket

This component is basically a Wall Band with additional side support struts which can be located below or above the band. In either case the band is located under the bead/swage at a joint between the components. The maximum length which can be supported by this component is 30 metres. Only available for diameters of 130mm and above. Constructed from stainless steel.

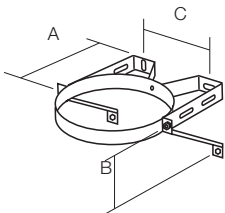

Size	Dimensions			Code Number
	A	B	C	
130mm	178	115	92	4051213
150mm	190	122	112	4051215
180mm	207	137	142	4051218
200mm	219	147	162	4051220
250mm	248	172	212	4051225
300mm	286	198	266	4051230
350mm	316	223	316	4051235
400mm	345	248	366	4051240

Wall Band

To be used at intervals not exceeding 2.5 metres to provide lateral stability for both vertical and horizontal applications within the system. Manufactured from stainless steel and suitable for both internal and external applications.

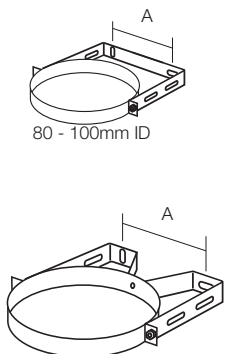

Size	A	Code Number
80mm	63.5	3115084
100mm	83.5	3115104
113mm	75	3115114
130mm	92	3115134
150mm	112	3115154
180mm	142	3115185
200mm	162	3115205
250mm	212	3115255
300mm	266	3115305
350mm	316	3115355
400mm	366	3115405
500mm	467	3115505
600mm	567	3115605

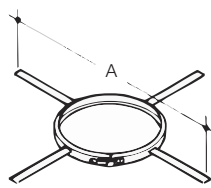

Location Band

This component consists of a strap which must be secured underneath a joint. It has four equally located stainless steel "spokes" designed to centrally locate and brace the system where lowered into an existing chimney or shaft, and should be used at intervals not exceeding 3 metres. Constructed from stainless steel.

Bespoke Location Bands to facilitate non-standard shafts can be manufactured to order. Please refer to SFL Technical Department with your requirement.

Size	A	Code Number
80mm	350	4017108
100mm	375	4017110
113mm	375	4017111
130mm	390	4017113
150mm	410	4017115
180mm	540	4017118
200mm	560	4017120
250mm	610	4017125
300mm	660	4017130
350mm	850	4017135
400mm	900	4017140
500mm	1000	4017150
600mm	1100	4017160

FLASHINGS AND WEATHERING

Flat Flashing

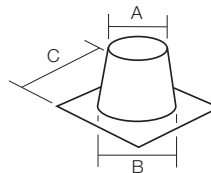

Size	Dimensions			Code Number
	A	B	C	
100mm	110	200	419	70000001
113mm	123	213	419	70000004
130mm	140	230	419	70000005
150mm	160	250	455	70000006
180mm	190	280	495	70000007
200mm	210	300	495	70000009
250mm	260	350	610	70000011
300mm	310	400	610	70000012
350mm	360	450	660	70000013
400mm	410	500	762	70000014
500mm	510	600	914	70000016
600mm	610	700	1015	70000018

5° - 30° Angled Flashing

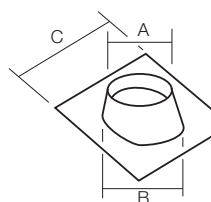

Size	Dimensions			Code Number
	A	B	C	
100mm	110	190	394	70053001
113mm	123	204	419	70053004
130mm	140	225	419	70053005
150mm	160	247	445	70053006
180mm	190	281	495	70053007
200mm	210	304	508	70053009
250mm	260	361	578	70053011
300mm	310	419	610	70053012
350mm	360	476	678	70053013
400mm	410	533	762	70053014
500mm	510	710	1010	70053016
600mm	610	824	1124	70053018

32° - 45° Angled Flashing

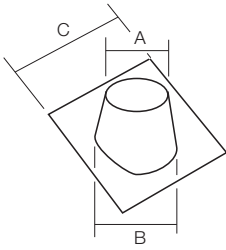

Size	Dimensions			Code Number
	A	B	C	
100mm	110	261	480	70324501
113mm	123	279	495	70324504
130mm	140	303	508	70324505
150mm	160	332	559	70324506
180mm	190	375	578	70324507
200mm	210	403	610	70324509
250mm	260	475	678	70324511
300mm	310	546	737	70324512
350mm	360	617	820	70324513
400mm	410	689	889	70324514
500mm	510	812	1124	70324516
600mm	610	963	1300	70324518

Storm Collar

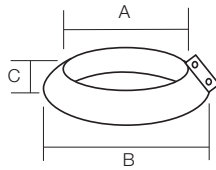

Size	Dimensions			Code Number
	A	B	C	
100mm	102	201	70	70123401
113mm	115	214	70	70123404
130mm	132	231	70	70123405
150mm	152	251	70	70123406
180mm	182	281	70	70123407
200mm	202	301	70	70123409
250mm	252	330	70	70123411
300mm	302	351	70	70123412
350mm	352	401	70	70123413
400mm	402	451	70	70123414
500mm	502	673	150	70123416
600mm	602	773	150	70123418

TERMINALS AND TERMINATION

Tapered Top Stub and Mesh

This terminal should be used with gas condensing appliances as it offers least resistance to flow and help minimise the effects of pluming.

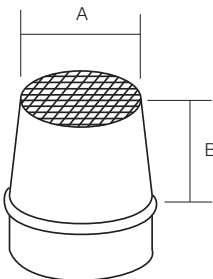

Size	Dimensions		Code Number
	A	B	
80mm	70	291	4016008
100mm	90	291	4016010
113mm	100	291	4016011
130mm	120	291	4016013
150mm	140	291	4016015
180mm	160	228	4016018
200mm	180	228	4016020
250mm	200	228	4016025
300mm	250	228	4016030
350mm	300	228	4016035
400mm	350	276	4026040
500mm	400	276	4026050
600mm	500	276	4026060

Tapered Top Stub

This terminal offers least resistance to the evacuation of flue gases and should only be used in accordance with the regulations.

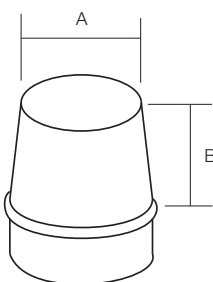

Size	Dimensions		Code Number
	A	B	
80mm	70	291	4015808
100mm	90	291	4015810
113mm	100	291	4015811
130mm	120	291	4015813
150mm	140	291	4015815
180mm	160	228	4015818
200mm	180	228	4015820
250mm	200	228	4015825
300mm	250	228	4015830
350mm	300	228	4015835
400mm	350	276	4025840
500mm	400	276	4025850
600mm	500	276	4025860

Rain Cap

This is a basic terminal that offers a degree of protection against rain ingress

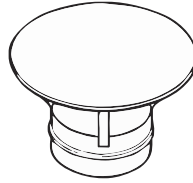

Size	Code Number
80mm	4055208
100mm	4055210
113mm	4055211
130mm	4055213
150mm	4055215
180mm	4055218
200mm	4055220
250mm	4055225
300mm	4055230
350mm	4055235
400mm	4055240
500mm	4055250
600mm	4055260

Gas Terminal

A terminal designed for use where Supra serves conventional gas fired equipment. Sizes 80mm to 150mm. Incorporates a bird screen/mesh.

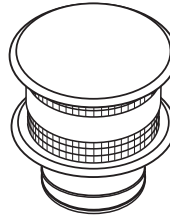

Size	Code Number
80mm	4006108
100mm	4006110
113mm	4006111
130mm	4006113
150mm	4006115
180mm	4006118
200mm	4006120
250mm	4006125
300mm	4006130
350mm	4006135
400mm	4006140
500mm	4006150
600mm	4006160

Supra Terminal Kit

The Supra Terminal Kit is designed for use where Supra is located within a chimney or shaft. It consists of a plate and a 100mm upstand (drum) which is traditionally weathered to the top of the shaft. The "drum" is significantly greater in diameter than the Supra product, to provide passive ventilation to the shaft / chimney. Four integral stainless steel straps centrally locate the Supra when the unit is lowered over the product. The projecting length of Supra above the "drum" is then rainproofed using the Storm Collar provided as part of the kit.

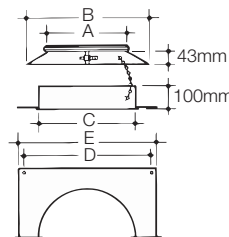
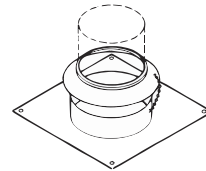

Size	Dimensions					Code Number
	A	B	C	D	E	
80mm	82	280	167	298	348	4005408
100mm	102	300	187	298	348	4005410
113mm	115	310	200	298	348	4005411
130mm	132	330	214	472	522	4005413
150mm	152	350	234	472	522	4005415
180mm	182	380	264	472	522	4005418
200mm	202	400	284	472	522	4005420
250mm	252	450	334	472	522	4005425
300mm	302	500	384	646	696	4005430
350mm	352	550	434	646	696	4005435
400mm	402	600	484	646	696	4005440
500mm	502	700	584	750	800	4005450
600mm	602	800	684	850	900	4005460

ELBOW OFFSET DIMENSIONS

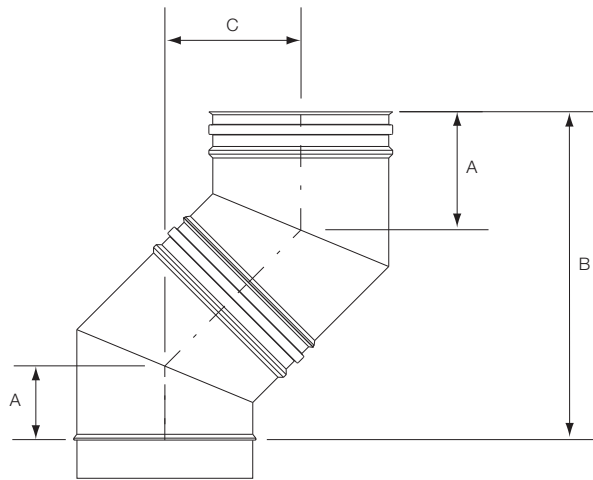

15° Offset

Size	Dimensions		
	A	B	C
80mm	43	281	37
100mm	47	296	39
113mm	36	226	30
130mm	38	234	31
150mm	39	238	32
180mm	52	288	39
200mm	53	291	39
250mm	56	303	40
300mm	60	319	42
350mm	63	331	44
400mm	82	393	52
500mm	89	426	56
600mm	96	448	59

30° Offset

Size	Dimensions		
	A	B	C
80mm	57	313	86
100mm	63	335	92
113mm	34	237	66
130mm	36	245	71
150mm	39	256	71
180mm	64	313	87
200mm	67	324	90
250mm	73	347	95
300mm	80	373	102
350mm	87	399	109
400mm	110	477	128
500mm	123	530	142
600mm	136	575	154

45° Offset

Size	Dimensions		
	A	B	C
80mm	72	328	143
100mm	83	365	158
113mm	42	234	105
130mm	46	248	110
150mm	50	261	116
180mm	77	324	141
200mm	81	337	145
250mm	92	375	161
300mm	102	409	175
350mm	112	443	189
400mm	139	537	222
500mm	160	608	254
600mm	180	677	281

TYPICAL CONDENSING APPLICATION

Fig. 3

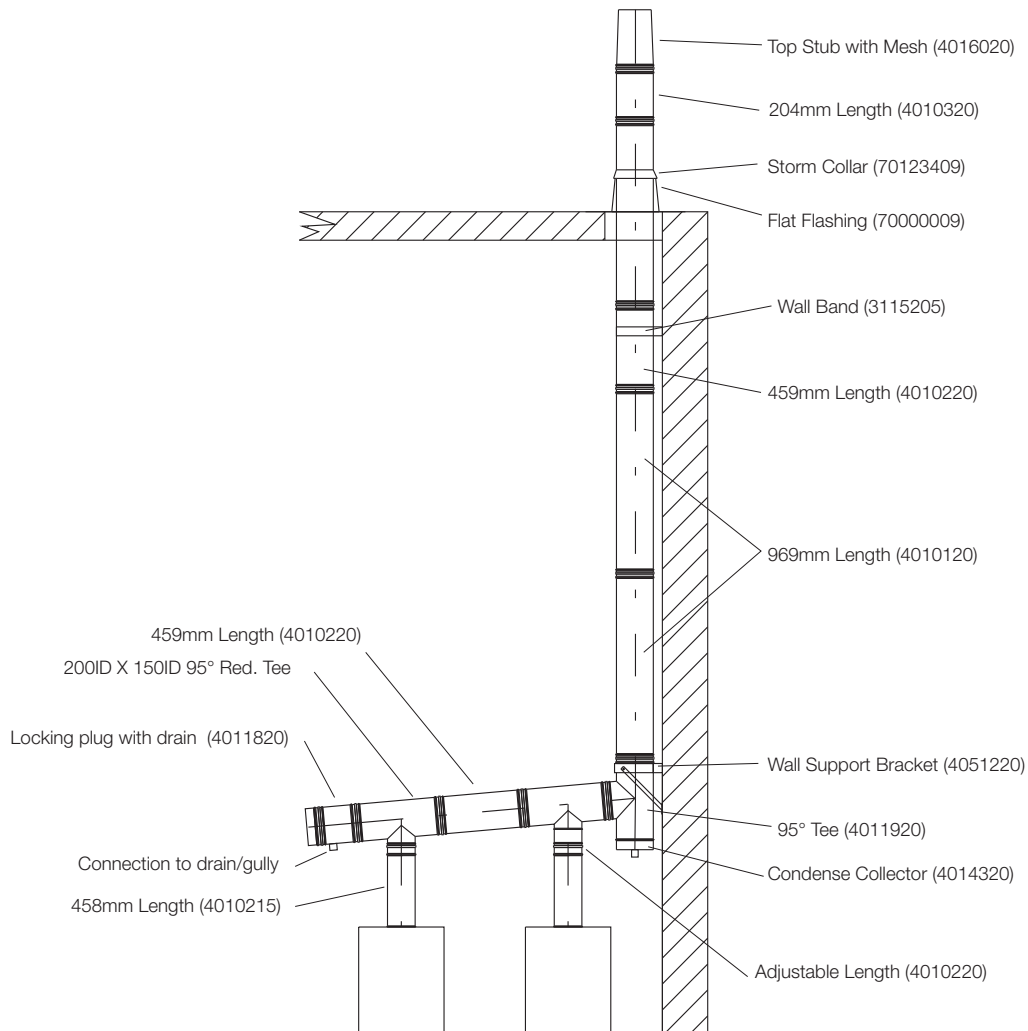

INSTALLATION INSTRUCTIONS

Mandatory Requirements

In all instances the requirements of the Building Regulations must be complied with and the appropriate references are: Document J of the DOE Building Regulations, Section F of the Building Standards (Scotland), Section L of the Building Regulations (Northern Ireland). Reference should also be made to the relevant British and European Standards governing the installation of flue and chimney products for the associated fuel and appliance types as detailed:

Solid Fuel and Oil Fired Applications: BS EN15287-1:2007
Domestic Gas Installations: BS5440: Part 1: 2008

Note: In the UK, connection to an appliance which is not connected to the fuel supply, may be carried out by a competent person. However, connection to an appliance that is connected to the fuel supply must be carried out by an approved and registered Heating Engineer, e.g. Gas Safe, HETAS (Solid Fuel) or OFTEC (Oil).

General

Supra must be applied such that the system complies with local / national Building Regulations and applicable standards. Where used on condensing appliances, the range of components will permit deliberate drainage of condensate, either back to the condensate removal components within the Supra System range, or through the heating appliance. No part of the flue system should be constructed to form an angle greater than 45° from the vertical. Although components are included that will permit horizontal applications, they should only be used for connection to the appliance. Where the system is being used for a condensing application, it is required that sloping connections run at an angle of 5° from the horizontal, using the Tees, Elbows and fittings designed for that purpose.

If the system is to be used within an existing chimney or purpose designed shaft, the range of support components will allow such configurations and can also be used to provide an independent and fully supported system both inside an outside a building. Where Supra is installed in exposed applications or where the external run is greater than 3.0 metres, SFL would recommend that the Nova SM product is used. Nova SM is a twin wall insulated stainless steel system offering a high degree protection against freezing. Adaptors are available to allow conversion between the two products (See Page 7).

Joining

The Supra system is jointed by pushing the male end into the female end of the proceeding component, and then applying a Locking Band. The Locking Band must be installed so that the toggle is only closed from left to right. See Fig. 4.

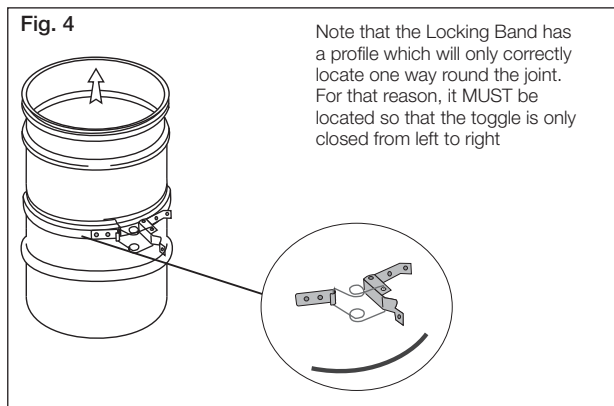

The Supra 0.5mm product is supplied complete with factory bonded Elastomer Seals. For 1mm Supra, depending on the application, the joint can be made pressure and moisture resistant using an Elastomer Seal which must be ordered separately. The Elastomer Seal should be located and ideally bonded as shown in Fig. 5

Note that the lips of the seal must point in one direction as shown. Because the seal is designed to provide a secure grip to the male end of the component, SFL Seal Lubricating gel should be used to facilitate ease of installation and to prevent potential damage of the seal during installation.

Ensure that both ends of the connecting joint are clean and free of dirt / grit.

Fig. 5 Standard Joint detail

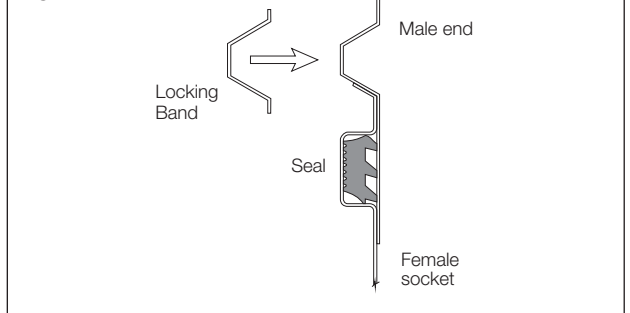

Adjustable Length

The Adjustable Length consists of a section of SUPRA, the lower non-beaded end of which is designed preferably to be located into a standard length. It can also be inserted into the female end of other components, but however applied, must engage to a depth equivalent to at least half of the diameter of the SUPRA being used. Where pressure and moisture resistance are required a special Locking Band & Seal is required to make the joint.

On standard Supra, the Adjustable Length is supplied complete with a special Locking Band & Seal. For Supra 1.0mm, the special Locking Band & Seal **MUST** be ordered separately.

Fig. 6 Lock Band detail for the Adjustable Length for Condensing Applications

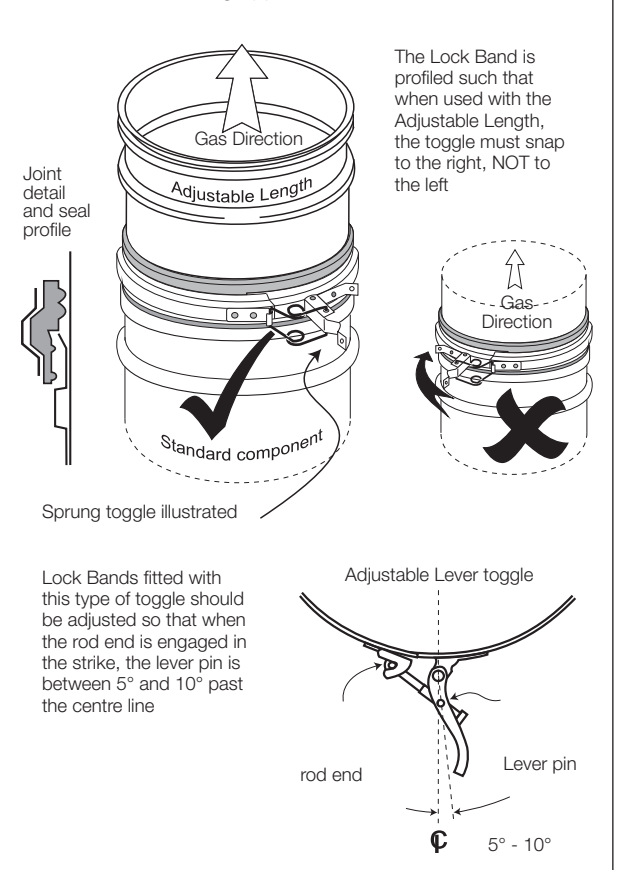

Fig. 6 illustrates the joint detail. Locate the seal over the socketed female end of the length or component female end **before** inserting the male end, and then pull the seal up so that the angled notch on its inside locates over the turned end of the female socket as shown. To facilitate easier assembly, apply SFL Joint Lubricant to the seal prior to installation. The Lock Band has two designs of toggle, either spring or adjustable. If using the band with the adjustable toggle, it should be tensioned as shown in Fig. 6 Note that whichever type is applied, the profile of the Lock Band is such that it must only be applied one way round. If it is located incorrectly, the joint will be both insecure and inadequately sealed.

Support

Supra must only be supported with the components in the system range. The maximum length of product run that can be supported by any component is 30 metres. Where lowered into an existing chimney or shaft, under no circumstances should the product be suspended from the top; always use a Support Lengths at the base of the chimney to lower from, which is designed for that purpose. The Wall Band and Bracing Bracket provide lateral stability only, and should be used at centres not exceeding 2.5 metres. The Location Band, used to centralise Supra where lowered into a chimney or shaft, should be used at intervals not exceeding 3 metres, and secured immediately underneath a joint. Where used as a liner, either a Support Plate or Wall Support must be used at the base to take the vertical load of the stack. Where the Supra product is free standing above the roof and its height exceeds 1.5 metres beyond the last support or the roof, a Bracing Bracket must be used and tied back to the structure..

Data Plate

It is a regulatory requirement that a data plate is to be completed, positioned and secured by the installer where a hearth, fireplace, flue or chimney is provided or extended. The data plate provides essential information regarding the performance, specification, designation and installation of the chimney system. The data plate is to be completed by the installer using an indelible ink and securely fixed in an unobtrusive but obvious position. Acceptable fixing positions would be next to the electricity consumer unit, water supply stop cock or gas meter within the building or by the chimney / hearth. The data plate detailed is provided by SFL, however many different data plates exist in the market and each design can be different and tailored to the supplying company.

Some data plates contain more or less information than detailed below in Fig. 7, however it is a requirement that all data plates have to provide the essential information deemed necessary under the regulatory requirement, as follows:-

Property address.

Where the chimney / hearth is installed.

What fuels the chimney is suitable for (firing capacity).

Is the chimney suitable for condensing appliances / applications.

Chimney internal diameter.

Installers name and address.

Date of installation.

Distance to combustible material.

Product designation of the chimney to EN 1443, if relevant.

Fig. 7

IMPORTANT SAFETY INFORMATION		CE
<p>This label must not be removed or covered</p>		
<p>Property Address Park House, Nova Road, Barnstaple, Ex31 1ZZ</p>		
<p>The chimney installed in the</p> <p><input type="checkbox"/> Ground Floor <input type="checkbox"/> Lounge <input type="checkbox"/> Kitchen <input type="checkbox"/> First Floor <input type="checkbox"/> Dining Room <input type="checkbox"/> Boiler Room</p>		<p>Are suitable for (Fuel Type)</p> <p><input checked="" type="checkbox"/> Gas <input type="checkbox"/> Oil (... Sec) <input type="checkbox"/> Solid Fuel <input type="checkbox"/> All Suitable for condensing appliances <input checked="" type="checkbox"/> Yes <input type="checkbox"/> No</p>
<p>Chimney Designation to BS EN 1443</p> <p>Temperature Pressure Capability</p> <p><input checked="" type="checkbox"/> T200 N1 (40Pa @ 2.0 l.s².m²) <input type="checkbox"/> T450 P1 (200Pa @ 0.006 l.s².m²) <input type="checkbox"/> T600 H1 (5000Pa @ 0.006 l.s².m²)</p>		<p>Condense Resistance</p> <p><input checked="" type="checkbox"/> W (WET) <input type="checkbox"/> D (DRY)</p>
<p>Internal diameter of chimney ...200... mm</p> <p>Chimney Product Brand: SFL Nova SM</p>		<p>Corrosion Resistance</p> <p><input type="checkbox"/> V1 <input type="checkbox"/> V2 <input type="checkbox"/> V3 <input type="checkbox"/> Vm</p> <p>Sootfire Resistance</p> <p><input checked="" type="checkbox"/> G (Yes) <input type="checkbox"/> O (No)</p> <p>Distance to combustible material (XX):50.....mm</p>
<p>Installation Details</p> <p>Company Name: Wonder Plumb Services Address: Unit X, Novaside Industrial Estate, Barnstaple, Devon, Ex31 2ZZ Phone Number: 01271 00011222</p> <p>Installed by: A Plumber Date of Installation: 3rd September 2006</p>		
<p>Important Information</p> <p>This chimney system must be cleaned and inspected on a regular basis. In any event, this should not be less than once per year and should be undertaken by an authorised sweep. Under no condition should black steel sweeping brushes or chemical chimney cleaners be used with this product. It is a requirement both under Building Regulations and CE that this plate is completed and installed within the guidelines contained therein.</p>		
<p>SFL, Pottington Business Park, Barnstaple, Devon, England EX311LZ</p>		

Provision for sweeping and cleaning

Adequate provision should be made for inspecting and cleaning the chimney system. This is particularly important for solid fuel applications. SFL would recommend that chimneys serving solid fuel appliances are swept as frequently as necessary but at least twice a year and possibly three times a year if the appliance is subject to long periods of slumbering. Access component are made available within the range and should be installed to suit the installation, unless sweeping can be undertaken through the appliance.

It is important that a visual inspection of the chimney is undertaken at the same time to insure all joints are sound and there is no evidence of a chimney fire having occurred.

Terminal Types

The Supra range offers a number of different terminal types to suit various applications. Where used on condensing appliances, the Top Stub with mesh would be preferable as this offers little additional resistance to the flue gases. The same Top Stub but without the mesh would also be the preferred option for solid fuel, providing there is a drainage point at the base of the chimney. As an alternative the Rain Cap could also be used to help reduce rain ingress into the chimney system. For gas fired appliances we would suggest that the Gas Terminal is used.

Testing

This is achieved by means of a flue flow test as detailed in BS5440: Part 1: 2008. This can be summarised as follows: After completing a visual and physical check of the system and joints, and ensuring adequate air supply for combustion has been provided in accordance with the appliance requirements, close all doors and windows in the room in which the appliance is installed.

Carry out a flow visualization check using a smoke pellet that generates at least 5m³ of smoke in 30s by placing the smoke pellet in the intended location of the appliance. Ensure that there is discharge of smoke from the correct terminal only and no leakage into the room. When the chimney is tested, there should be:

- No significant escape of smoke from the appliance position.
- No seepage of smoke over the length of the chimney.
- A discharge of smoke from only the correct terminal.

If these conditions are not met, then the test has failed and all faults must be rectified and the system re-tested and passed before connection of the appliance to the fuel supply is undertaken. For further information please refer to the relevant standards and publications.

Note: A smoke test is subjective and by the nature of the product standards a chimney is allowed a degree of leakage as defined in BS EN 1856-1. For this reasons some wisps of smoke may be seen over the length of the chimney and this should not necessarily constitute a failure. It is therefore a matter of expert judgement as to whether significant leakage constitutes a failure. A product with a performance designation under EN 1856-1 with a leakage classification of N1 is allowed a maximum leakage rate of up to 2.01/s/m² at a positive pressure of 40Pa.

For further information and guidance please refer to Appendix E of the Building Regulations Part J.

Handling

The product is relatively easy to handle, but care should be taken when holding, fitting or assembling any part of the system. Users are advised to take suitable procurations, gloves etc., to avoid injury on any sharp exposed edges.

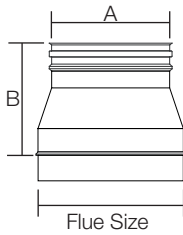

Reducers

Reducers are used to reduce the diameter of the preceding system by one diameter, e.g. 150ID to 130ID.

Flue Size	A (mm)	B (mm)	Code (0.5mm)	Code (1mm)
100mm	80	150	4012610	-
113mm	80	150	4012911	-
113mm	100	120	4012611	-
130mm	113	120	4012613	-
150mm	130	120	4012615	-
180mm	150	120	4012618	4022618
200mm	180	120	4012620	4022620
250mm	200	165	4012625	4022625
300mm	250	165	4012630	4022630
350mm	300	165	4012635	4022635

Note: Bespoke Reducers and Increasesers can be manufactured to order, please send a dimensioned drawing detailing your requirements to SFL Technical Dept., who will evaluate your requirements.

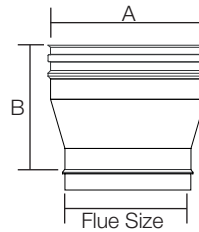

Increasesers

Increasesers are used to increase the diameter of the preceding system by one diameter, e.g. 130ID to 150ID.

Flue Size	A (mm)	B (mm)	Code (0.5mm)	Code (1mm)
80mm	100	150	4013008	-
80mm	113	150	4012908	-
100mm	113	120	4013010	-
113mm	130	120	4013011	-
130mm	150	120	4013013	-
150mm	180	150	4013015	-
180mm	200	120	4013018	4023018
200mm	250	165	4013020	4023020
250mm	300	165	4013025	4023025
300mm	350	165	4013030	4023030
350mm	400	165	4013035	4023035



Dörenter Str. 139b
48429 Rheine

Tel. 05971/807780
Fax. 05971/980929
free. 0800/52646984
mail. mail@edelstahl-schornsteine.com